

Oberteil von Außen
lid from the outside

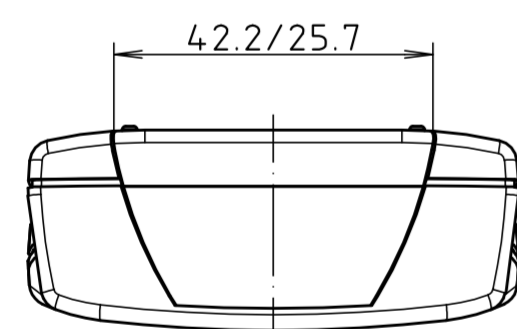

Unterteil von Innen
base from the inside

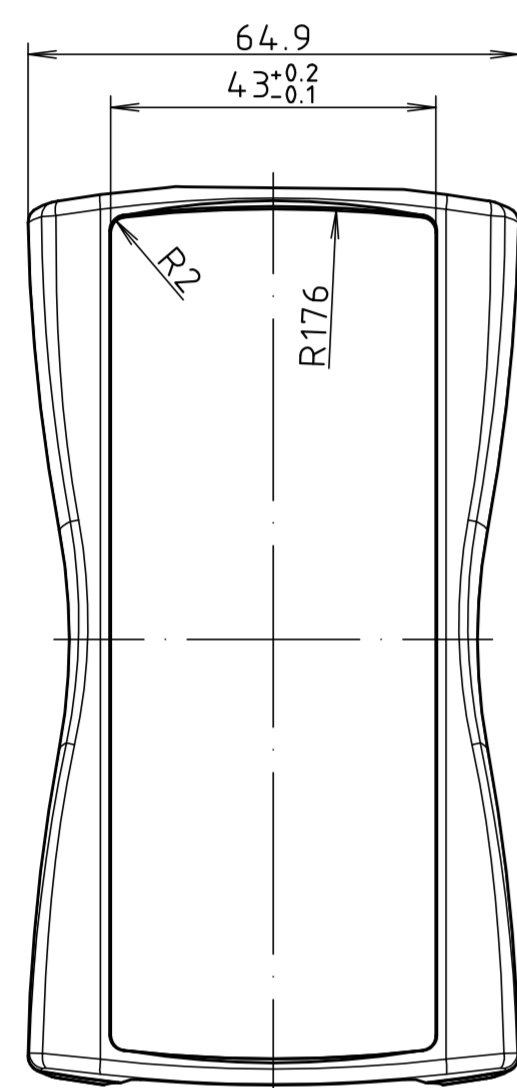
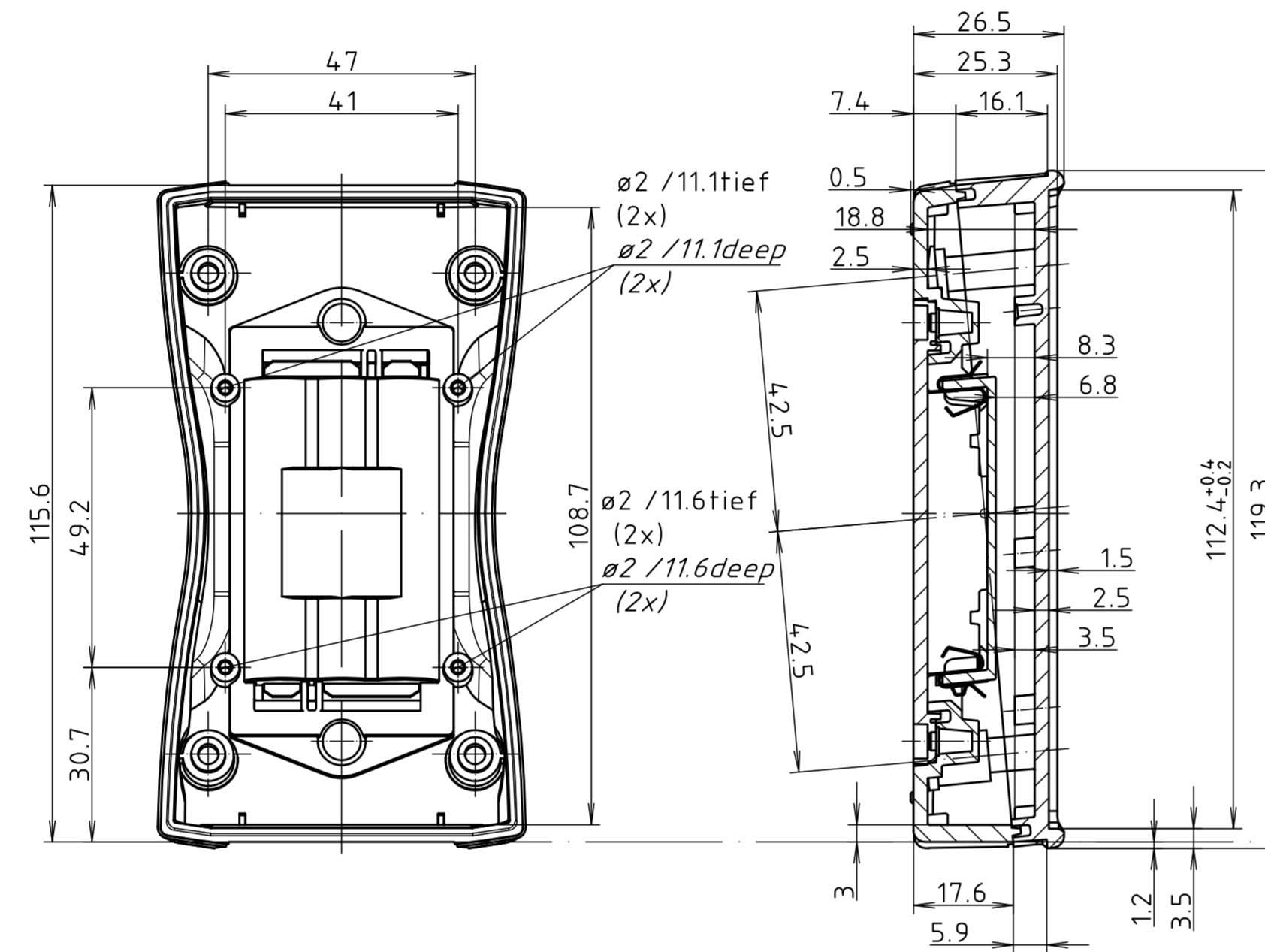

Oberteil von Innen
lid from the inside

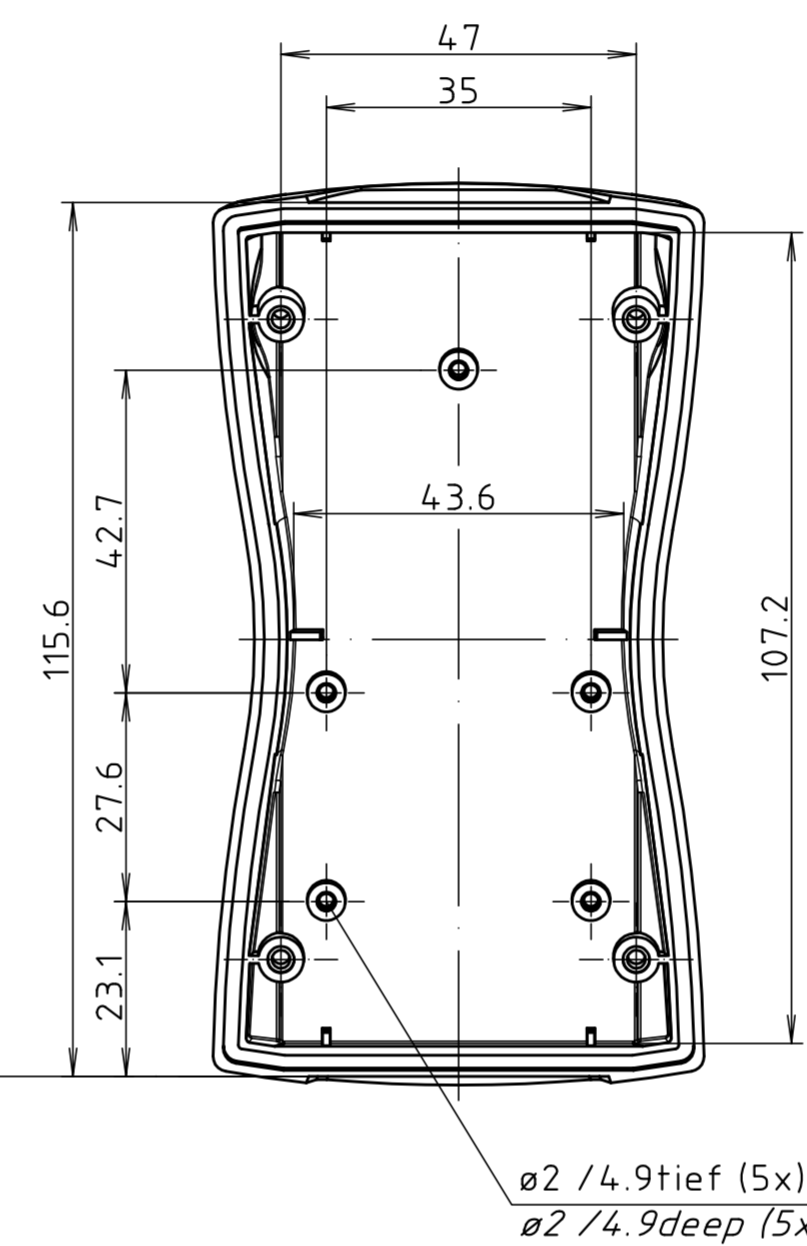

Unterteil von Außen
base from the outside

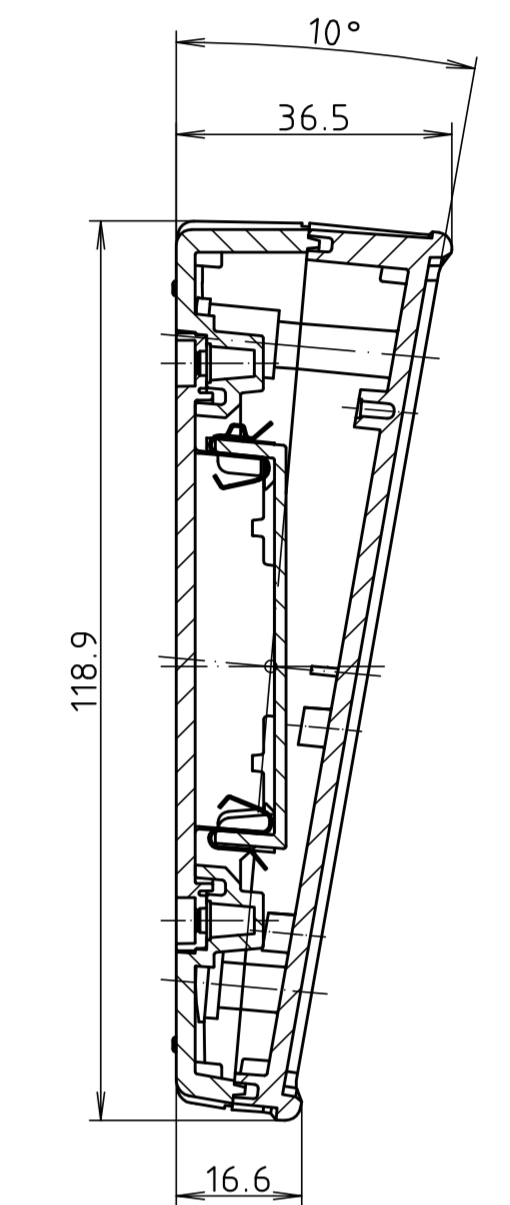
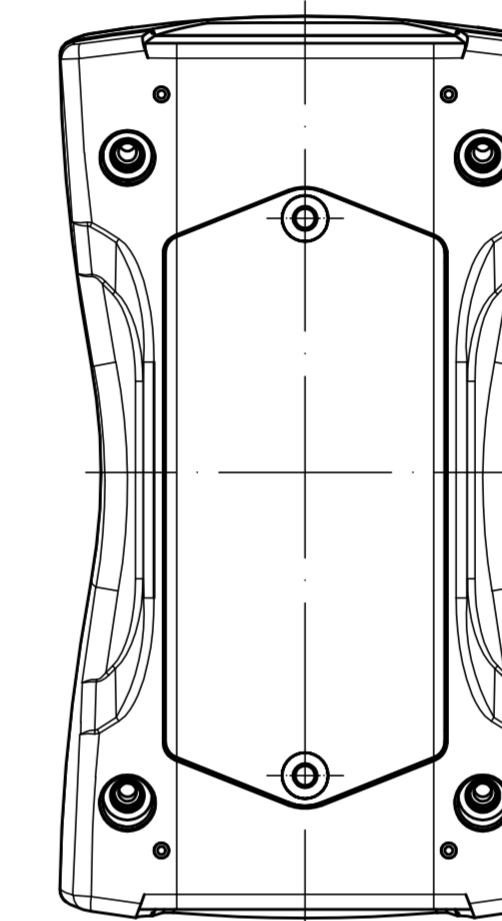

parallel montiert
parallel assembled

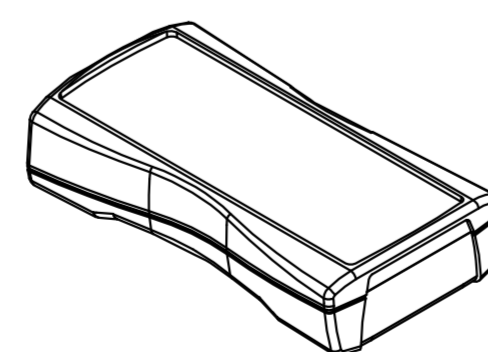

pultförmig montiert
inclined assembled

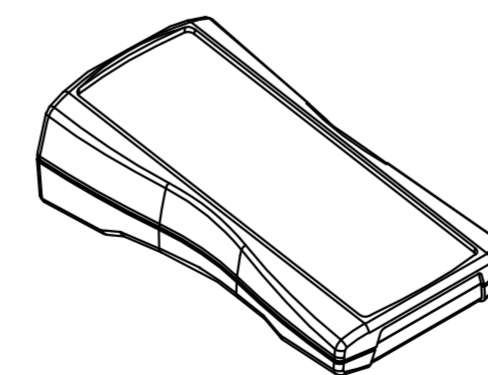

Modell / model	Ausführung / version
BS 401 F	IP 40, nicht aufrüstbar auf IP 65 (Batteriefach ohne Dichtung) IP 40, not upgradable to IP 65 (battery compartment without cord seal)
BS 403 F	IP 40, aufrüstbar auf IP 65 mit BS 400 DI-D (Batteriefach mit Rundschnurdichtung) IP 40, upgradable to IP 65 by fitting BS 400 DI-D (battery compartment with cord seal)
BS 404 F	IP 65 durch integrierte Rundschnurdichtungen, (keine Verwendung mit BS 400 DI-D möglich) IP 65 with integrated cord seal. (Use of BS 400 DI-D is not possible)

Maßstab / Scale: 1:1

Zeichnungs-Nr. / Drawing-No.: 1K 5355.030.02

Artikel / Article: BS 401 / 403 / 404 F
 Katalogzeichnung / Catalogue drawing

3930 02.02.2010
 A-Nr. / Datum / Alt.-No. / Date:

DISK: 2 802 681
 Datum / Date: 11.05.06 KH