

ISO (1 : 2)

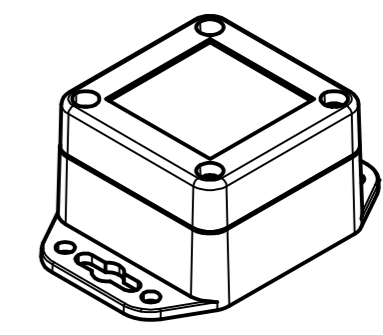

Maßstab/ Scale: 1:1 (1:2)		
Zeichnungs-Nr. / Drawing-No.: 2K 5475.002.01		
Artikel / Article: EUROMAS XM/XT 060604 WL Katalogzg./Catalogue draw.		
A.Nr./ Alt.No.	Datum/ Date:	 BOPLA A Phoenix Mecano Company
DISK:	2504597.idw	
Datum/Date: 11.03.2022 KH		