

Darstellung ohne Faltenbalg  
view without bellow

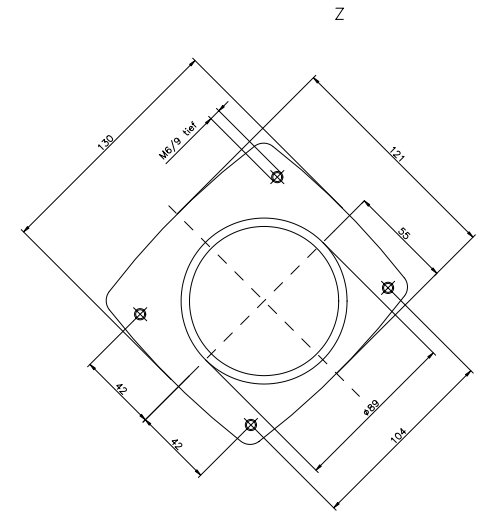
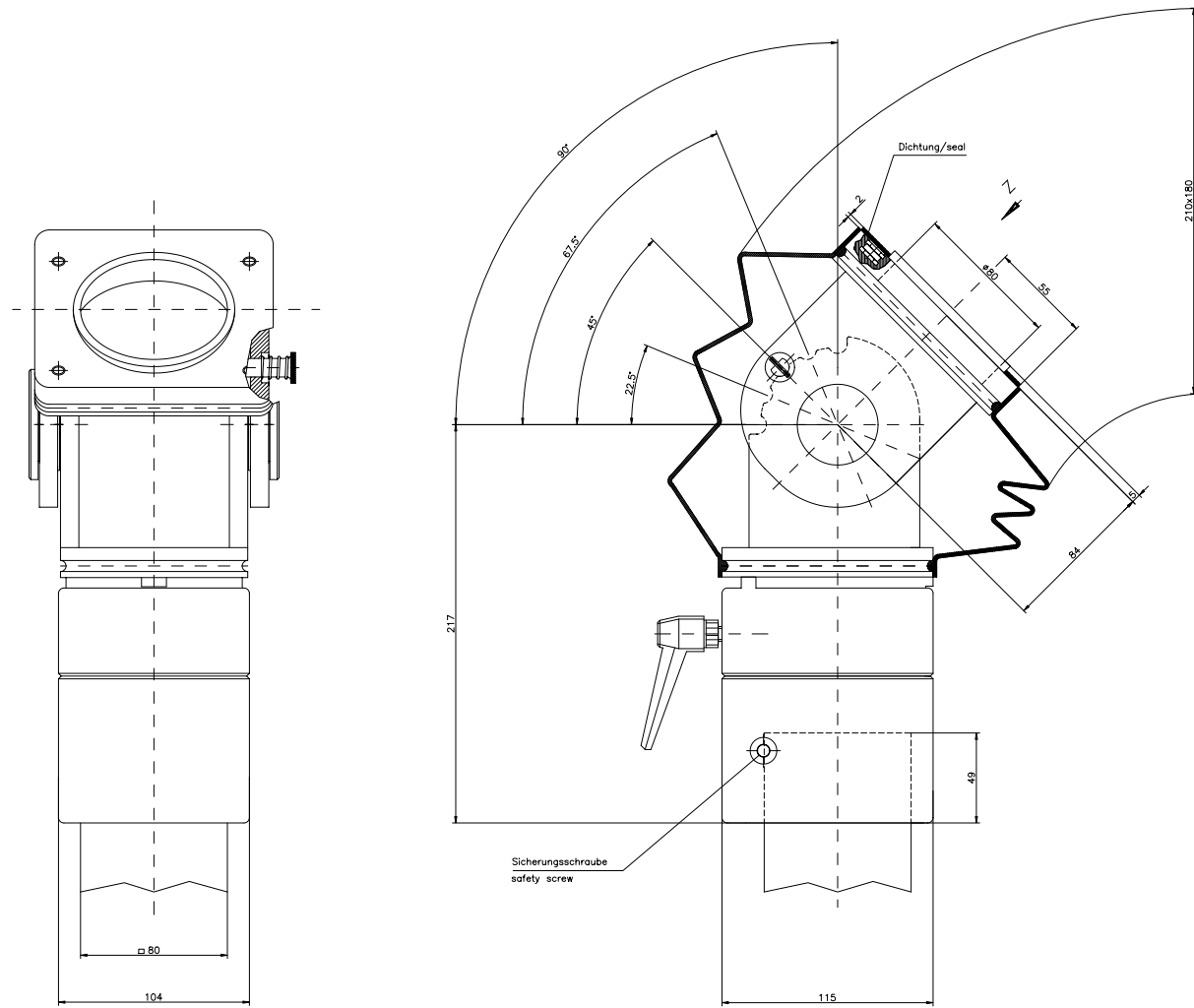

Pultkupplung DN GT80/2  
Bestell-Nr. 49.816200